

# M16613

## INSTALLATION INSTRUCTIONS SHEET

### START FROM HERE

- Make sure power is completely off at the fuse box.
- Have your fixture installed by a qualified licensed electrician
- Prepare everything in clear area.
- Wear gloves at all times during this installation.
- Read instructions carefully before you start assembly.
- Keep this instruction sheet for future reference.

**Technical Support:** 1-844-628-8368

### Please Note:

- All Matteo Lighting fixtures come with pre-wired module(s).
- Unless instructed to do so, please do not touch any part of the module(s) as unnecessary contact with the module could cause permanent damage.

THIS LUMINAIRE MUST BE MOUNTED OR SUPPORTED IN A JUNCTION BOX  
*CE LUMINAIRE DOIT ÊTRE MONTÉ OU SUPPORTÉ DANS UNE BOÎTE  
DE JONCTION*

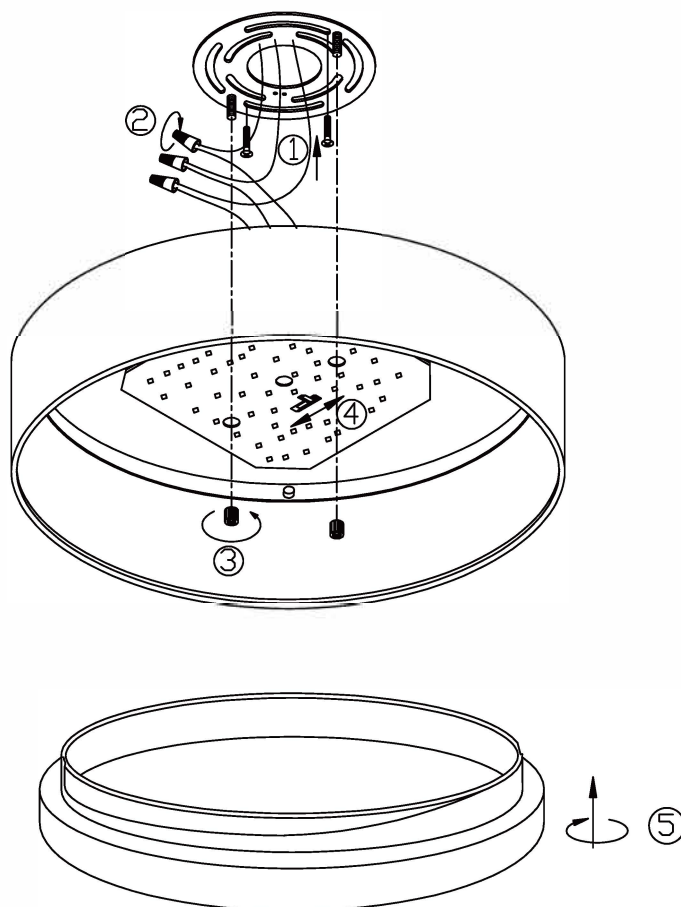

- Ensure main supply is switched off
- Fit mounting plate onto electrical junction box with screws (1).
- Connect wires (2) according to colour (White to White, Black to Black), connect all earth lug together onto the crossbar with green screw to tight.
- Fit lamp body onto mounting plate with canopy screws (3).
- Select colour temperature desired with the 3CCT switch (4).
- Twist lock the acrylic lampshade into the fixture (5) .
- Reconnect power.
- Light source: AC LED 20W, 3CCT: 3000K, 4000K, 5000K, CRI90.

### WARNING:

- This fitting must be earthed.
- Disconnect power and allow fitting to cool down before cleaning or changing the lamp.